

Magnetostrictive Sensors  
**BTL7-E500-M0254-Z-SA418-S32**  
**Order Code: BTL2199**

**BALLUFF**

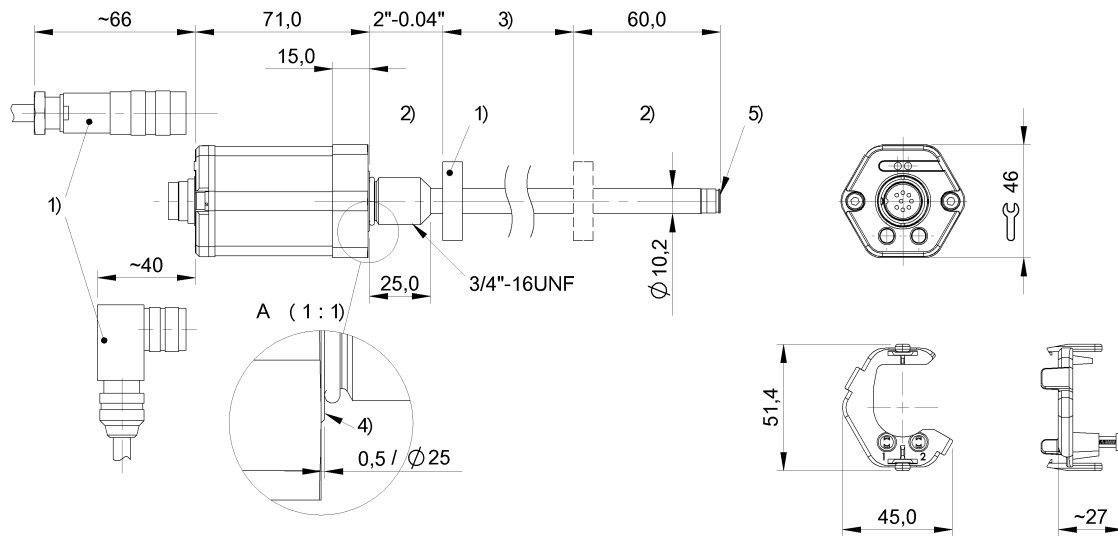

1) not included in scope of delivery, 2) Non-usable area, 3) Nominal length = Measuring length, 4) Mounting surface, 5) Internal threads M4x4/6 deep



**Basic features**

<b>Approval/Conformity</b>	CE UKCA cULus WEEE
<b>Base type</b>	BTL7-E...-M....-Z-S...
<b>Magnets, number (factory setting)</b>	1
<b>Magnets, number max.</b>	1

**Electrical connection**

<b>Connection</b>	Connector, M16x0.75, 8-pin
<b>Connection version</b>	axial
<b>Polarity reversal protected</b>	Ub up to 36 V
<b>Short-circuit protection</b>	to GND and to 36 V DC

**Electrical data**

<b>Current consumption max. at 24 V DC</b>	150 mA
<b>Error signal Ia rising</b>	3.6 mA
<b>Galvanic isolation</b>	no
<b>Inrush current</b>	≤ 500 mA/10 ms
<b>Operating voltage Ub</b>	10...30 VDC
<b>Output signal adjustable</b>	with calibration aid using programming inputs
<b>Overvoltage protection</b>	Ub up to 36 V
<b>Switch-on delay max.</b>	600 ms
<b>Voltage-proof up to (GND to housing)</b>	500 V AC

**Environmental conditions**

<b>Ambient temperature</b>	-40...85 °C
<b>EN 55016-2-3, Radiation</b>	For industrial and residential use
<b>EN 60068-2-27, Continuous shock</b>	150 g, 2 ms
<b>EN 60068-2-27, Shock</b>	150 g, 6 ms
<b>EN 60068-2-6, Vibration</b>	20 g, 10...2000 Hz
<b>EN 61000-4-2, ESD</b>	Severity Level 3
<b>EN 61000-4-3, RFI</b>	Severity Level 3
<b>EN 61000-4-4, Burst</b>	Severity Level 3
<b>EN 61000-4-5, Surge</b>	Severity Level 2
<b>EN 61000-4-6, High-frequency fields</b>	Severity Level 3
<b>EN 61000-4-8 Magnetic fields</b>	Severity Level 4
<b>IP rating</b>	IP67, with connector
<b>Relative humidity</b>	≤ 90 %, non-condensing
<b>Storage temperature</b>	-40...100 °C
<b>Temperature coefficient typ.</b>	≤ 30 ppm/K at 50% of nominal stroke 500mm

**Functional safety**

<b>MTTF (40 °C)</b>	58 a
---------------------	------

**Interface**

<b>Analog output</b>	Analog, current 4...20 mA
----------------------	---------------------------

Magnetostrictive Sensors  
**BTL7-E500-M0254-Z-SA418-S32**  
Order Code: BTL2199

**BALLUFF**

**Material**

Cover material	Aluminium, Die-cast, nickel plated
Housing material	Aluminium, Anodized
Housing material, surface protection	Anodized
Material flange	1.3960 stainless steel
O-ring material	FKM
Plug material	1.4571 stainless steel
Protection tube material	1.4571 stainless steel

**Mechanical data**

Installation length from contact surface	365 mm
Mounting part	Threaded flange 3/4-16UNF
Null point	50.8 mm
Pressure rating max.	600 bar
Protection tube diameter	10.2 mm
Tightening torque max.	100 Nm

**Range/Distance**

Measuring length	254 mm
Repeat accuracy	± 5 µm
Sampling frequency max.	1000 Hz

**Connector Drawings**

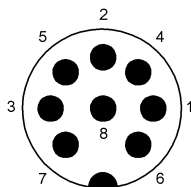

**Wiring Diagrams**

Pin	
1	4...20 mA
2	0V
3	NC
4	La
5	NC
6	GND
7	+24 V DC
8	Lb